

Inside Cabinet

Step 1

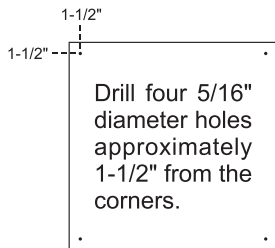

Step 2

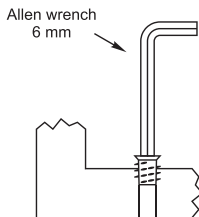

Step 3

Screw in feet.

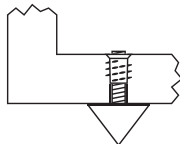

Outside Cabinet

Step 1

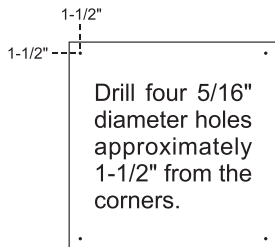

Step 2

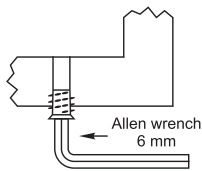

Step 3

Screw in feet.

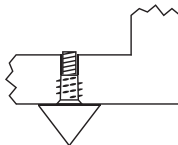

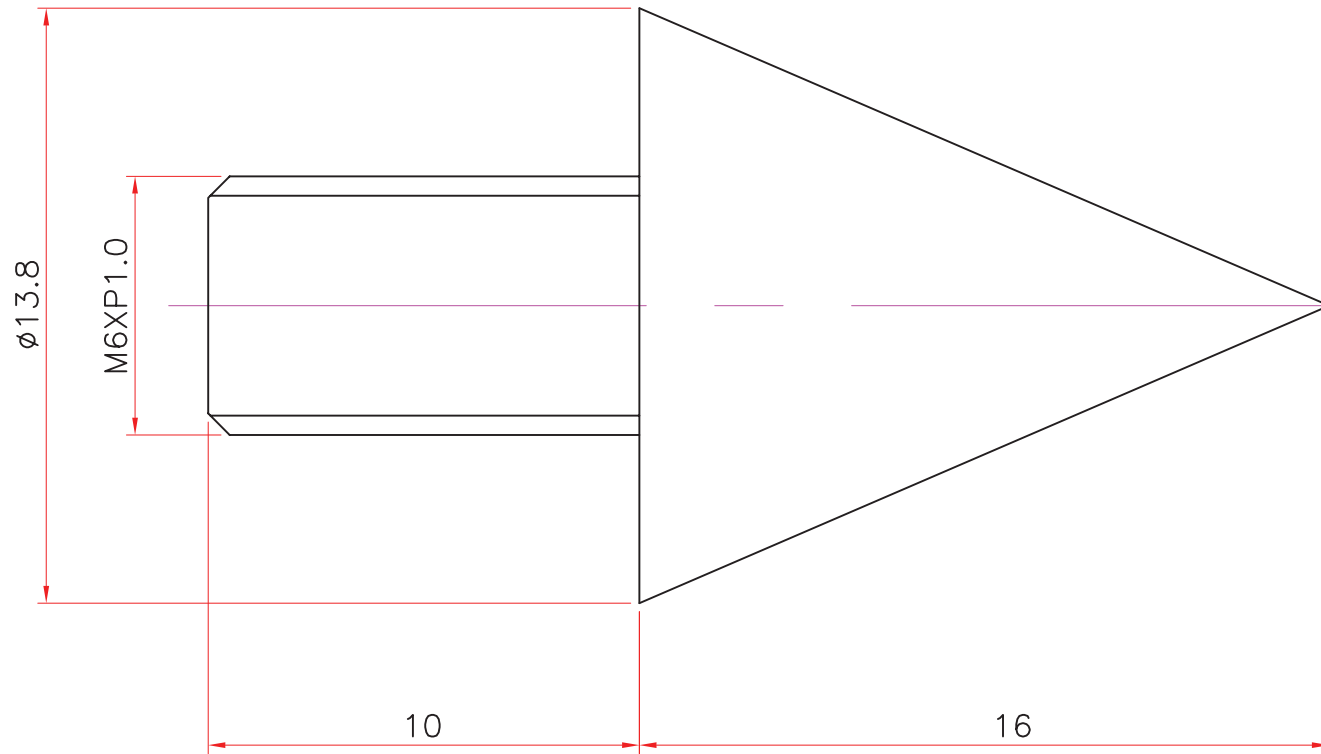

© Dayton Audio® 2010

RevNo	Revision note	Date	Signature	Checked	Approved	Designed by	Checked by	Approved by	Date	Scale	Edition
1:						AH	BKM	KK	2/2011	None	A
2:							Model: DSS2				Unit
3:					Name: Spike Foot				Sheet		
4:									1 of 1		